

# **USER MANUAL**

# ***Pro Lite***

## **LCD Monitor**

ENGLISH

### ***Pro Lite XUB3293UHSN***

Thank you very much for choosing the iiyama LCD monitor.

We recommend that you take a few minutes to read carefully through this brief but comprehensive manual before installing and switching on the monitor. Please keep this manual in a safe place for your future reference.



**Dear user, we congratulate you on the purchase of your iiyama LCD.**

For details on warranty and locally used pixel policies that apply directly after installation of your product please check the iiyama website.

**To report a fault, please contact your local support centre found at <https://iiyama.com>**

**Things to check before you call the iiyama information line**

- | if the power cable is connected securely and turned on?
- | if the display has been turned on?
- | if the signal cable is connected securely and the correct input selected?
- | if the computer has been restarted with the display connected?
- | if the graphics card is correctly installed with the latest drivers possible?
- | if the correct native resolution has been selected via 'Display Properties'?
- | If the R/G/B signal configuration is correct?
- | if the displays On Screen Menu is shown?
- | if the correct brightness and contrast settings have been set?
- | if given display tolerances and compatibility have been considered?
- | if via the On Screen Menu you have performed a Factory Reset/Recall?



**Before reporting the screen defect, please prepare the following information/evidence:**

- | model number \*
- | purchase receipt and serial number \*
- | name and address for collection
- | telephone/fax number, for availability during the day
- | convenient collection date (date, time)
- | short description of the defect

**Important Note:**

If there is no fault found in the collected equipment after inspection, the transferring party shall incur charges for transport and administration.

If you have checked all of the above and there is still no picture, call our information line for assistance in your country.

\* see the identification plate on the back of the case.

## CE MARKING DECLARATION OF CONFORMITY

This LCD monitor complies with the requirements of the EC/EU Directive 2014/30/EU "EMC Directive", 2014/35/EU "Low Voltage Directive", 2009/125/EC "ErP Directive" and 2011/65/EU "RoHS Directive".

The electro-magnetic susceptibility has been chosen at a level that gives correct operation in residential areas, business and light industrial premises and small-scale enterprises, inside as well as outside of the buildings. All places of operation are characterized by their connection to the public low voltage power supply system.

IYAMA CORPORATION: Wijkmeerstraat 8, 2131 HA Hoofddorp, The Netherlands

Model No. : PL3293UH



We recommend recycling of used product. Please contact your dealer or iiyama service center. Recycle information is obtained via the Internet, using the address: <https://iiyama.com>

You can access the Web page of different countries from there.

- We reserve the right to change specifications without notice.
- All trademarks used in this user manual are the property of their respective owners.
- Eprel registration number XUB3293UHSN-B5 : 1576606

# TABLE OF CONTENTS

|   |    |
|---|----|
| FOR YOUR SAFETY.....                            | 1  |
| SAFETY PRECAUTIONS.....                         | 1  |
| SPECIAL NOTES ON LCD MONITORS.....              | 3  |
| CUSTOMER SERVICE.....                           | 3  |
| CLEANING.....                                   | 3  |
| BEFORE YOU OPERATE THE MONITOR.....             | 4  |
| FEATURES.....                                   | 4  |
| CHECKING THE CONTENTS OF THE PACKAGE.....       | 4  |
| USING ARM OR STAND.....                         | 5  |
| FITTING AND REMOVAL OF STAND.....               | 6  |
| CONTROLS AND CONNECTORS.....                    | 7  |
| CONNECTING YOUR MONITOR.....                    | 8  |
| COMPUTER SETTING.....                           | 10 |
| ADJUSTING THE HEIGHT AND THE VIEWING ANGLE..... | 10 |
| OPERATING THE MONITOR.....                      | 11 |
| ADJUSTMENT MENU CONTENTS.....                   | 12 |
| STANDBY FEATURE.....                            | 21 |
| TROUBLE SHOOTING.....                           | 22 |
| RECYCLING INFORMATION.....                      | 23 |
| APPENDIX.....                                   | 24 |
| SPECIFICATIONS : ProLite XUB3293UHSN-B5.....    | 24 |
| DIMENSIONS.....                                 | 25 |
| COMPLIANT TIMING.....                           | 25 |

# FOR YOUR SAFETY

## SAFETY PRECAUTIONS

### WARNING

#### **STOP OPERATING THE MONITOR IF YOU ARE AWARE OF ANY PROBLEMS**

If you notice any abnormal phenomena such as smoke, strange sounds or fumes, unplug the monitor and contact your dealer or iiyama service center immediately. Further use may be dangerous and can cause fire or electric shock.

#### **NEVER REMOVE THE CABINET**

High voltage circuits are inside the monitor. Removing the cabinet may expose you to the danger of fire or electric shock.

#### **DO NOT PUT ANY OBJECT INTO THE MONITOR**

Do not put any solid objects or liquids such as water into the monitor. In case of an accident, unplug your monitor immediately and contact your dealer or iiyama service center. Using the monitor with any object inside may cause fire, electric shock or damage.

#### **INSTALL THE MONITOR ON A FLAT, STABLE SURFACE**

The monitor may cause an injury if it falls or is dropped.

#### **DO NOT USE THE MONITOR NEAR WATER**

Do not use where water may be splashed or spilt onto the monitor as it may cause fire or electric shock.

#### **OPERATE UNDER THE SPECIFIED POWER SUPPLY**

Be sure to operate the monitor only with the specified power supply. Use of an incorrect voltage will cause malfunction and may cause fire or electric shock.

#### **PROTECT THE CABLES**

Do not pull or bend the power cable and signal cable. Do not place the monitor or any other heavy objects on the cables. If damaged, the cables may cause fire or electric shock.

#### **ADVERSE WEATHER CONDITIONS**

It is advisable not to operate the monitor during a heavy thunder storm as the continual breaks in power may cause malfunction. It is also advised not to touch the plug in these circumstances as it may cause electric shock.

### CAUTION

#### **INSTALLATION LOCATION**

Do not install the monitor where sudden temperature changes may occur, or in humid, dusty or smoky areas as it may cause fire, electric shock or damage. You should also avoid areas where the sun shines directly on the monitor.

## CAUTION

### DO NOT PLACE THE MONITOR IN A HAZARDOUS POSITION

The monitor may topple and cause injury if not suitably located. Please also ensure that you do not place any heavy objects on the monitor, and that all cables are routed such that children may not pull the cables and possibly cause injury.

### MAINTAIN GOOD VENTILATION

Ventilation slots are provided to keep the monitor from overheating. Covering the slots may cause fire. To allow adequate air circulation, place the monitor at least 10cm (or 4 inches) from any walls. When removing the tilt stand, the ventilation slots on the back side of the monitor can be blocked. This may overheat the monitor and may cause fire or damage. Make sure to allow enough ventilation when removing the tilt stand. Operating the monitor on its back, side, upside down or on a carpet or any other soft material may also cause damage.

### DISCONNECT THE CABLES WHEN YOU MOVE THE MONITOR

When you move the monitor, turn off the power switch, unplug the monitor and be sure the signal cable is disconnected. If you do not disconnect them, it may cause fire or electric shock.

### UNPLUG THE MONITOR

If the monitor is not in use for a long period of time it is recommended that it is left unplugged to avoid accidents.

### HOLD THE PLUG WHEN DISCONNECTING

To disconnect the power cable or signal cable, always pull it by the plug. Never pull on the cable itself as this may cause fire or electric shock.

### DO NOT TOUCH THE PLUG WITH WET HANDS

Pulling or inserting the plug with wet hands may cause electric shock.

### WHEN YOU INSTALL THE MONITOR ON YOUR COMPUTER

Be sure the computer is strong enough to hold the weight of the monitor, otherwise, you may damage your computer.

### CAREFUL! PROTECT YOUR HANDS AND FINGERS

- Be careful not to hurt your fingers or hands when you change the height or the angle.
- Injury can occur if care is not taken to avoid finger contact with the displays base when adjusting the height.

### REMARK FOR 24/7 USAGE

This product is not specifically designed for 24/7 usage in all environments.

### REMARK FOR WALL MOUNTING

This product is not designed for digital signage (electronic signboard) applications such as wall mounting.

## OTHERS

### ERGONOMIC RECOMMENDATIONS

To eliminate eye fatigue, do not operate the monitor against a bright background or in a dark room. For optimal viewing comfort, the monitor should be just below eye level and 40-60cm (16-24 inches) away from your eyes. When using the monitor over a prolonged time, a ten minute break every hour is recommended as looking at the screen continuously can cause eye strain.

## SPECIAL NOTES ON LCD MONITORS

The following symptoms are normal with LCD monitors and do not indicate a problem.

- NOTE**
- When you first turn on the LCD monitor, the picture may not fit in the display area because of the type of computer that is used. In this case, adjust the picture position to the correct position.
  - You may find slightly uneven brightness on the screen depending on the desktop pattern you use.
  - Due to the nature of the LCD screen, an afterimage of the previous screen may remain after switching the image, when the same image is displayed for hours. In this case, the screen can be recovered slowly by changing the image or turning off the Power Switch for some hours.

## CUSTOMER SERVICE

- NOTE**
- If you have to return your unit for service and the original packaging has been discarded, please contact your dealer or iiyama service center for advice or replacement packaging.

## CLEANING

- WARNING**
- If you drop any materials or liquids such as water into the monitor when cleaning, unplug the power cable immediately and contact your dealer or iiyama service center.

- CAUTION**
- For safety reasons, turn off the power switch and unplug the monitor before you clean it.

- NOTE**
- To protect the LCD panel, do not scratch or rub the screen with a hard object.
  - Never use any of the following strong solvents. These will damage the cabinet and the LCD screen.

|                  |                          |
|------------------|--------------------------|
| Thinner          | Spray-type cleaner       |
| Benzine          | Wax                      |
| Abrasive cleaner | Acid or Alkaline solvent |

- Touching the cabinet with any product made from rubber or plastic for a long time may cause degeneration or loss of paint on the cabinet.

**CABINET** Stains can be removed with a cloth lightly moistened with a mild detergent solvent. Then wipe the cabinet with a soft dry cloth.

**LCD** Periodic cleaning with a soft dry cloth is recommended.

**SCREEN** Don't use tissue paper etc. because these will damage the LCD screen.

# BEFORE YOU OPERATE THE MONITOR

## FEATURES

- ◆ Supports Resolutions up to 3840 × 2160
- ◆ High Contrast 1000:1 (Typical), Advanced Contrast Function Available, Brightness 350cd/m<sup>2</sup> (Typical), Quick Response Time 4ms (Gray to Gray)
- ◆ Flicker - Free
- ◆ Blue Light Reducer
- ◆ Digital Character Smoothing
- ◆ USB Type-C / RJ45 - Connectors
- ◆ USB Power Delivery supports up to 65W
- ◆ 2 × 3W Stereo Speakers
- ◆ Standby Feature
- ◆ VESA Mounting Standard (100mm×100mm) Compliant
- ◆ Keyhole for Security Lock

## CHECKING THE CONTENTS OF THE PACKAGE

The following accessories are included in your package. Check to see if they are enclosed with the monitor. If anything is missing or damaged, please contact your local iiyama dealer or regional iiyama office.

- |                           |                      |                     |
|---------------------------|----------------------|---------------------|
| ■ Power Cable*            | ■ HDMI Cable         | ■ DisplayPort Cable |
| ■ USB Cable (C to C)      | ■ USB Cable (A to B) | ■ Stand-Neck        |
| ■ Stand-Base with a screw | ■ Screwdriver        | ■ Safety Guide      |
| ■ Quick Start Guide       |                      |                     |

### CAUTION

- \* The rating of the Power Cable enclosed in 120V area is 10A/125V. If you are using a power supply higher than this rating, then a power cable with a rating of 10A/250V must be used. However, all guarantees and warranties are void for any problems or damage caused by a power cable not supplied by iiyama. An approved power cable greater or equal to H05VVVF, 3G, 0.75mm<sup>2</sup> must be used.



## USING ARM OR STAND

### CAUTION

- Before installation, make sure the display arm or desk arm stand is strong enough to hold the necessary weight of the monitor and the mount.
- Panel angle adjustment range : 23° upward and 5° downward

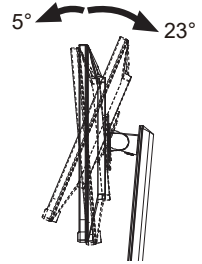

## [ DISPLAY ARM OR DESK ARM STAND ]

### CAUTION

- When you use with the display arm or desk arm stand, in consideration of thickness of the mounting stage, tighten the M4 Screws (4pcs) which "L" length is 10mm to fasten the monitor. Using the screw longer than this may cause electric shock or damage because it may contact with the electrical parts inside the monitor.

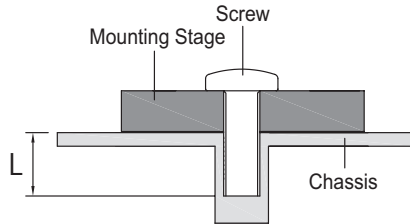

## [ LANDSCAPE MODE ]

This monitor can only be used in landscape. Do not rotate or operate the monitor in any other orientation than landscape.

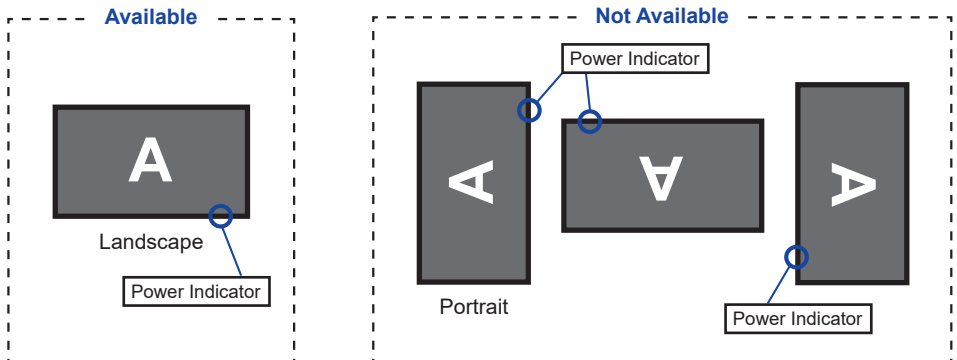

## FITTING AND REMOVAL OF STAND

### CAUTION

- Put the monitor on a stable surface. The monitor may cause injury or damage if it falls or is dropped.
- Do not give a strong impact to the monitor. It may cause damage.
- Unplug the monitor before removal or installation to avoid an electric shock or a damage.

### <Installation>

- ① Put a piece of soft cloth on the table beforehand to prevent the monitor from being scratched. Lay the monitor flat on a table with front face down.
- ② Install the Stand-Neck to the monitor and then tighten the 'thumb screw' with the provided screwdriver to secure them.

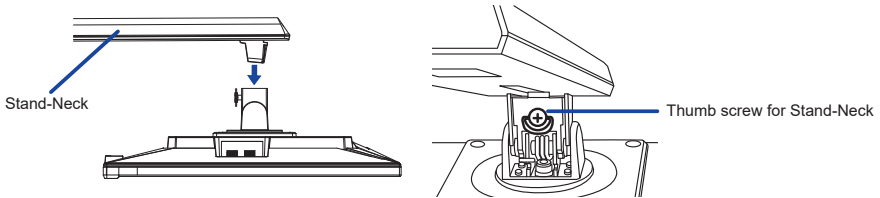

- ③ Install the Stand-Base to the Stand-Neck and then tighten the 'thumb screw' to secure them.

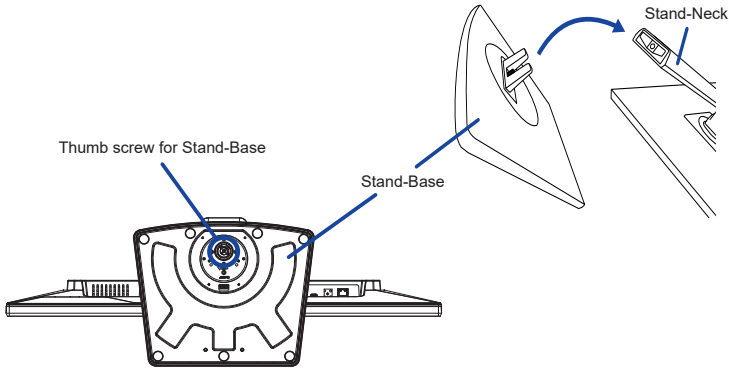

### <Removal>

- ① Put a piece of soft cloth on the table beforehand to prevent the monitor from being scratched. Lay the monitor flat on a table with front face down.
- ② Loosen the 'thumb screw' to remove the Stand-Base from the Stand-Neck.
- ③ Loosen the 'thumb screw' with the provided screwdriver to remove the Stand-Neck from the monitor.

## CONTROLS AND CONNECTORS

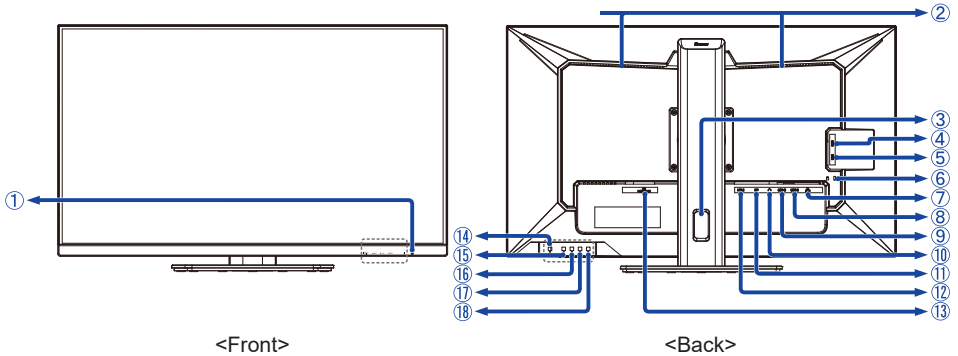

### ① Power Indicator

**NOTE** Blue: Normal operation  
Orange: Standby mode

### ② Speakers

### ③ Cable Hole

### ④ USB Downstream Connector (USB3.2 Gen 1: 5Gbps, 5V, 900mA) (USB)

### ⑤ USB Downstream Connector (USB3.2 Gen 1: 5Gbps, 5V, 900mA) (USB)

### ⑥ Keyhole for Security Lock

**NOTE** You can fasten a security lock and cable to prevent the monitor from being removed without your permission.

### ⑦ LAN(RJ45) Connector ( )

### ⑧ USB Upstream Connector (USB B)

### ⑨ USB Type-C Connector (USB3.2 Gen 1: 5Gbps, 20V, 3.25A) (USB C)

### ⑩ Headphone Connector ( )

### ⑪ DisplayPort Connector (DP)

### ⑫ HDMI Connector (HDMI)

### ⑬ AC Connector ( ~ : Alternating current) (AC POWER IN)

### ⑭ Power Button ( )

### ⑮ Menu Button (MENU)

### ⑯ Right / Volume Button ( / ) \*

### ⑰ Left / ECO Mode Button ( / ) \*

### ⑱ Input Select / Exit Button (INPUT/EXIT) \*

\* You can skip the Menu items and directly display an option setting screen or an adjustment scale.

## CONNECTING YOUR MONITOR

- ① Ensure that both the computer and the monitor are switched off.
- ② Connect the computer to the monitor with the signal cable.
- ③ Connect the computer to the monitor with the USB Cable (A to B).
- ④ Connect the computer to the monitor with the USB Cable (C to C) when viewing images on your monitor through the USB Type-C Connector or when using the monitor's USB hub function.\*
- ⑤ Connect the Power Cable to the monitor first and then to the power source.
- ⑥ Turn on your monitor and computer.

- \* ● When charging connected device via USB Type-C Connector, check if the device is equipped with a USB Type-C Connector that supports charging function via USB PD (=Power Delivery).
- Turn on the "USB BC" function to allow connected device to be charged even when the monitor is in standby mode. See page 18 for USB Battery Charge (USB BC) function.
- The USB power delivery is up to 65W. If the connected device required more than 65W for operation or for boot up (when the battery is drained), use the original power adapter that came with the device.
- If a separately purchased USB Type-C Cable is used, make sure the cable is certified by USB-IF and is full-featured with power delivery and video / audio / data transfer functions.
- If the monitor is in standby mode, it will not display a picture automatically in the following situations:
  1. First boot of the PC
  2. When the PC is resuming from standby modeTo display a picture, press the INPUT Button. This behaviour is normal. To prevent this behaviour, please access the OSD menu and set "USB BC" to "ON".
- USB C to A cable is not included with the monitor. If you use a USB C to A cable, please note that you can only transfer data.
- Compatibility with all connected devices is not guaranteed due to different user environments.

### NOTE

- Make sure that the building installation has a circuit breaker of 120/240V, 20A (maximum).
- The signal cables used for connecting the computer and monitor may vary with the type of computer used. An incorrect connection may cause serious damage to both the monitor and the computer. The cable supplied with the monitor is for a standard connector. If a special cable is required please contact your local iiyama dealer or regional iiyama office.
- The Class I pluggable equipment Type A must be connected to protective earth.
- The socket-outlet shall be installed near the equipment and shall be easily accessible.
- Excessive sound pressure from ear-/headphones can cause hearing damage/hearing loss.

## [ Example of Connection ]

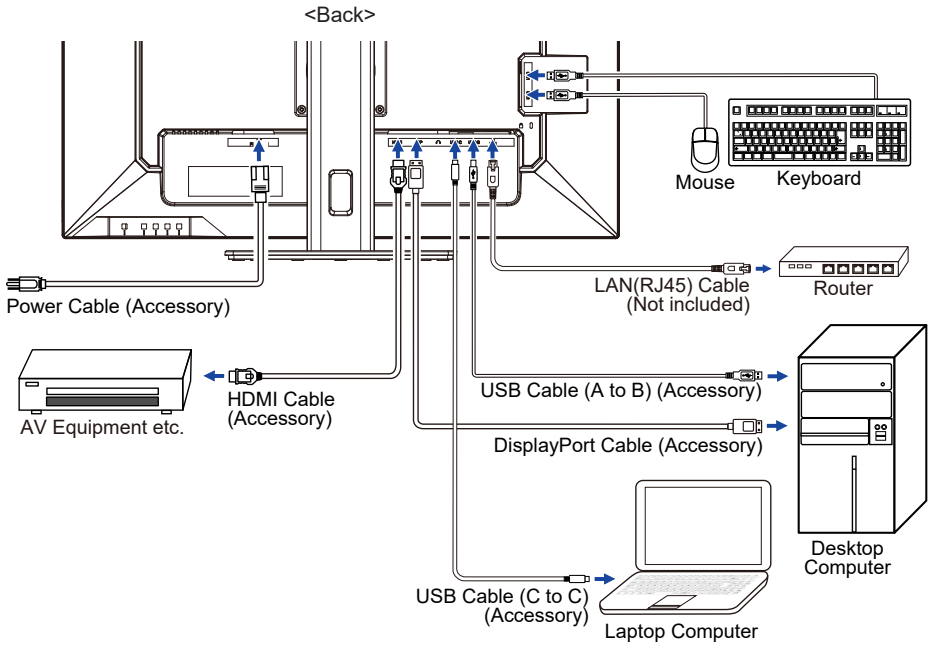

ENGLISH

## [ Collect Cables ]

Put the cables through the Cable Hole to bundle them.

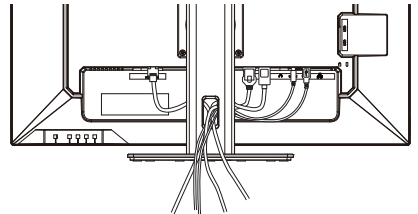

## COMPUTER SETTING

### ■ Signal Timing

Change to the desired signal timing listed on page 25: COMPLIANT TIMING.

## ADJUSTING THE HEIGHT AND THE VIEWING ANGLE

- For optimal viewing it is recommended to position yourself directly opposite to the full face of the monitor, then adjust the monitor's height and angle to your own preference.
- Hold the panel so that the monitor does not topple when you change the monitor's height or angle.
- You are able to adjust the monitor's height up to 150mm, angle up to 45° right and left, 23° upward and 5° downward.

- NOTE**
- Do not touch the LCD screen when you change the height or the angle. It may cause damage or break the LCD screen.
  - Careful attention is required not to pinch your fingers or hands into the moving part of the stand when you change the angle.
  - Injury can occur if care is not taken to avoid finger contact with the displays base when adjusting the height.

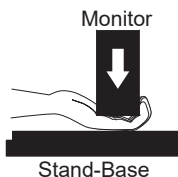
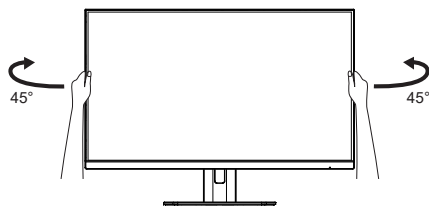
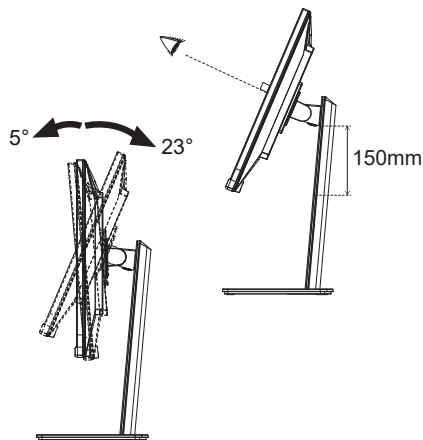

# OPERATING THE MONITOR

To create the best picture, your iiyama LCD monitor has been preset at the factory with the COMPLIANT TIMING shown on page 25. You are also able to adjust the picture by following the button operation shown below.

- ① Press the MENU Button to start the On Screen Display (OSD) feature. There are additional Menu items which can be switched by using the ◀ / ▶ Buttons.



- ② Select the Menu item which contains the adjustment icon relating to the adjustment you want to make. Press the MENU Button. Then, use the ◀ / ▶ Buttons to highlight the desired adjustment icon.
- ③ Press the MENU Button again. Use the ◀ / ▶ Buttons to make the appropriate adjustment or setting.
- ④ Press the EXIT Button to leave the menu, and the settings you just made would be automatically saved.

For example, to correct for OSD vertical position, select Menu item of OSD Settings and press the MENU Button. Then, select OSD V. Position by using the ◀ / ▶ Buttons and press the MENU Button. Use the ◀ / ▶ Buttons to change the OSD vertical position settings. The OSD vertical position should be changing accordingly while you are doing this.

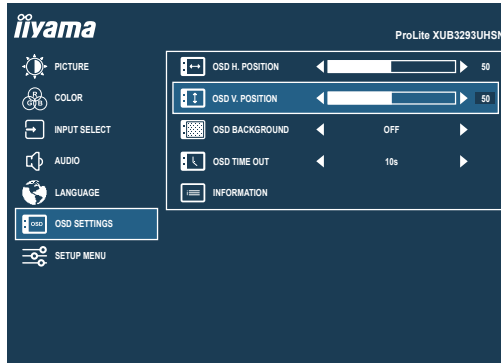

When you press the EXIT Button to end the adjustment, all changes are saved in the memory.

## NOTE

- When button operations are aborted during adjustment, On-Screen Display disappears when the time set for the OSD Time Out has passed. Also, the EXIT Button can be used to return previous menu and turn off the On Screen Display.
- Any changes are automatically saved in the memory when the On Screen Display disappears. Turning off the power should be avoided while using the Menu.

# ADJUSTMENT MENU CONTENTS

## Picture \*1

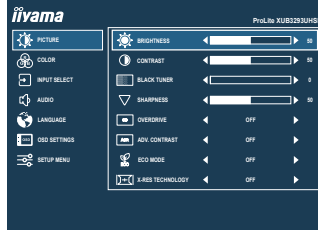

| Adjustment Item  | Problem / Option  |   | Button to Press |
|--|---|---|-----------------|
| Brightness *2  | Too dark<br>Too bright  |   |                 |
| Contrast   | Too dull<br>Too intense   |   |                 |
| Black Tuner  | From -5 to +5<br>You can adjust Dark shades.  |   |                 |
| Sharpness  | You can change the picture quality from 0 to 100 (soft to sharp).<br>Press the  Button to change the picture quality in numerical order. Press the  Button to change the picture quality in reverse numerical order.<br>Adjust the picture quality at resolutions of less than 3840 × 2160. |   |                 |
| Overdrive  | Off / 1 / 2 / 3 / 4 / 5<br>Improve the gray level response time of the LCD panel.<br>A higher level results in a faster response time.  |   |                 |
| Adv. Contrast  | On  | Increase Contrast Ratio                               |                 |
|  | Off   | Typical Contrast Ratio                                |                 |
| ECO Mode <span style="background-color: #0070C0; color: white; padding: 2px 5px; font-weight: bold;">Direct</span> | Off   | Normal  |                 |
|  | 1   | Brightness of back-light is reduced.                  |                 |
|  | 2   | Brightness of back-light is reduced more than 1.      |                 |
|  | 3   | Brightness of back-light is reduced more than 2.      |                 |
| X-Res Technology   | Off   | Normal  |                 |
|  | Soft  | Enhance the picture edge.                             |                 |
|  | Middle  | Enhance the picture edge more than the Soft option.   |                 |
|  | Hard  | Enhance the picture edge more than the Middle option. |                 |

\*1 Adjustable / settable items depend on which item is activated. See page 20 Function Correlation Matrix for more details.

\*2 Adjust the Brightness when you are using the monitor in a dark room and feel the screen is too bright.



## Direct

You can skip the Menu items and directly display an option setting screen by using the following button operations.

- ECO Mode: Press the  Button when the Menu is not displayed.



Color \*

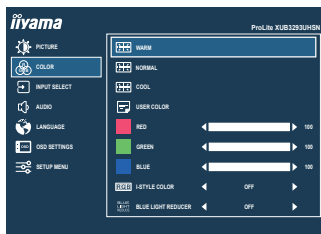

| Adjustment Item                  | Problem / Option |   | Button to Press |
|----------------------------------|------------------|---|-----------------|
| Warm                             | Warm color       |   |                 |
| Normal                           | Normal color     |   |                 |
| Cool                             | Cool color       |   |                 |
| User Color                       | Red              | Too weak  | ▶               |
|                                  | Green            | Too strong  | ◀               |
|                                  | Blue             |   |                 |
| i-Style Color                    | Standard         | For general windows environment and monitor default setting     |                 |
|                                  | Game             | For PC game environment   |                 |
|                                  | Cinema           | For movie and video environment                                 |                 |
|                                  | Scenery          | For displaying outdoor scenery images                           |                 |
|                                  | Text             | For text editing and viewing in a word processing environment   |                 |
|                                  | Off              | Return to a state set by color adjustment except i-Style Color. |                 |
| Blue Light Reducer <b>Direct</b> | Off              | Typical   |                 |
|                                  | 1                | Blue light is reduced.  |                 |
|                                  | 2                | Blue light is reduced more than 1.                              |                 |
|                                  | 3                | Blue light is reduced more than 2.                              |                 |

\* Adjustable / settable items depend on which item is activated. See page 20 Function Correlation Matrix for more details.

### Direct

You can skip the Menu items and directly display an option setting screen by using the following button operations.

- Blue Light Reducer: Keep pressing the INPUT/EXIT Button for about 2 seconds when the Menu is not displayed.



**Input Select**  
**Direct**

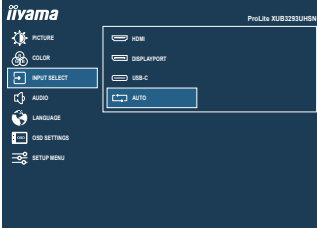

| Adjustment Item | Option      |  |
|-----------------|-------------|--|
| Input Select    | HDMI        | Select the HDMI input.   |
|                 | DISPLAYPORT | Select the DisplayPort input.                                  |
|                 | USB-C       | Select the USB Type-C input.                                   |
|                 | AUTO        | Search for an available input source and select automatically. |





**NOTE** "AUTO" function enables automatic selection of the input sources available. The input source from the computer in standby mode can not be selected. If you manually select one of the input sources, the other source is not automatically selected.

**Direct**

You can skip the Menu items and directly display an option setting screen by using the following button operations.

- Input Select: Press the INPUT/EXIT Button when the Menu is not displayed.





| Adjustment Item |               | Problem / Option     |  | Button to Press  |
|-----------------|---------------|----------------------|--|--|
| Volume          | <b>Direct</b> | Too soft<br>Too loud |  |  <br>  |
| Mute            | <b>Direct</b> | On                   | Turn off the sound temporarily.                |  |
|                 |               | Off                  | Return the sound volume to the previous level. |  |



**Direct**

You can skip the Menu items and directly display an adjustment scale or an option setting screen by using the following button operations.

- Volume: Press the  Button when the Menu is not displayed.
- Mute: Keep pressing the  Button for about 2 seconds when the Menu is not displayed. Mute and Unmute are switched by repeating the above button operation.



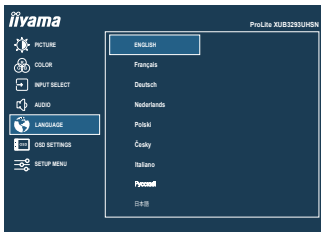





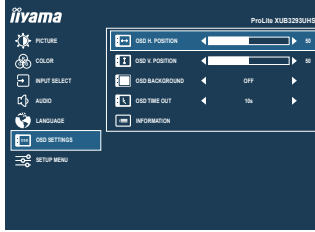







| Adjustment Item |            | Option  |          |          |  |
|-----------------|------------|---------|----------|----------|--|
| Language        | English    | English | Česky    | Czech    |  |
|                 | Français   | French  | Italiano | Italian  |  |
|                 | Deutsch    | German  | Русский  | Russian  |  |
|                 | Nederlands | Dutch   | 日本語      | Japanese |  |
|                 | Polski     | Polish  |          |          |  |





## OSD Settings



| Adjustment Item | Problem / Option  | Button to Press  |
|-----------------|---|--|
| OSD H. Position | OSD is too left<br>OSD is too right   |  <br>  |
| OSD V. Position | OSD is too low<br>OSD is too high   |  <br>  |
| OSD Background  | The background of OSD is made transparent.<br>Off / 1 / 2 / 3 / 4   |  <br>  |
| OSD Time Out    | You can set the OSD display duration time.<br>5 / 10 / 30 / 60 seconds  |  <br>  |
| Information     | <p>Display the information regarding the current input signal coming from the graphic card in your computer.</p> <p>&lt;Example&gt;</p>  <div data-bbox="680 820 754 852" style="background-color: #0056b3; color: white; padding: 2px 5px; font-weight: bold;">NOTE</div> <p data-bbox="680 865 1031 944">See your graphic card user guide for more information about changing the resolution and refresh rate.</p> |  |

## Setup Menu

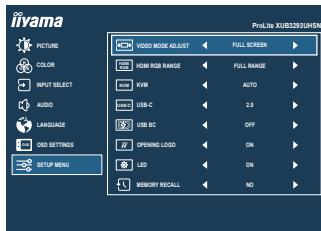

| Adjustment Item   | Option                      |  |
|---|-----------------------------|--|
| Video Mode Adjust   | Full Screen                 | Full screen display  |
|   | Aspect Ratio * <sup>1</sup> | Expansion display of Aspect  |
|   | Dot By Dot * <sup>1</sup>   | Display the picture dot by dot.  |
| HDMI RGB Range * <sup>2</sup>   | Full Range                  | For full-range color scale signal  |
|   | Limited Range               | For limited color scale signal   |
| KVM   | USB B                       | When two or three computers are connected to the monitor, you can link the input source with the USB upstream connector. |
|   | USB C                       |  |
|   | Auto                        |  |
| USB-C   | 2.0                         | Select the data transfer speed when connecting via USB Type-C.   |
|   | 3.0                         |  |
| <p><b>NOTE</b> When 3.0 is selected on USB Type-C input, 3840 × 2160 resolution at 60Hz cannot be supported.</p>  |                             |  |
| USB BC  | On                          | USB devices can be charged even when the monitor is in the standby mode.   |
|   | Off                         | USB devices can not be charged when the monitor is in the standby mode.  |
| <p><b>NOTE</b> When the monitor is turned off, USB devices cannot be charged even when the USB BC function is on.<br/>While this function is off, USB devices do not operate even when the monitor is in standby mode to save standby electricity. When operating USB devices, turn this function on.</p> |                             |  |
| Opening Logo  | On                          | iiyama Logo is displayed when the monitor is turned on.  |
|   | Off                         | iiyama Logo is not displayed when the monitor is turned on.  |
| LED   | On                          | The Power Indicator is turned On.  |
|   | Off                         | The Power Indicator is turned Off.   |
| <p><b>NOTE</b> Turn Off the Power Indicator when you are bothered by the light.</p>   |                             |  |
| Memory Recall   | Yes                         | Factory-preset data is restored.   |
|   | No                          | Return to Menu.  |

\*<sup>1</sup> Selectable only at resolutions 3840 × 2160 or less.

\*<sup>2</sup> Available for HDMI input only.

## ● Lock Mode

### <OSD Menu>

1. The OSD lock will be activated by pressing the MENU and ► Buttons for 10 seconds. If you try to access the OSD by pressing any of the buttons, message "OSD LOCKED" will appear on the screen.
2. The OSD lock will be deactivated by pressing the MENU and ► Buttons again for 10 seconds.

### <Power Button>

1. The Power Button lock will be activated by pressing the MENU and ◀ Buttons for 10 seconds. Locking the Power Button means that won't be able to turn off the Monitor while the Power Button is locked. If you press the Power Button, message "POWER BUTTON LOCKED" will appear on the screen.
2. The Power Button lock will be deactivated by pressing the MENU and ◀ Buttons again for 10 seconds.

■ Function Correlation Matrix

| Selected item / Active item |                    | Picture    |          |             |           |           |               |          | Color                |            |               |                    |
|-----------------------------|--------------------|------------|----------|-------------|-----------|-----------|---------------|----------|----------------------|------------|---------------|--------------------|
|                             |                    | Brightness | Contrast | Black Tuner | Sharpness | Overdrive | Adv. Contrast | ECO Mode | Warm / Normal / Cool | User Color | i-Style Color | Blue Light Reducer |
| Picture                     | Adv. Contrast      | -          | ✓        | ✓           | ✓         | ✓         | ✓             | -        | ✓                    | ✓          | ✓             | -                  |
|                             | ECO Mode           | -          | ✓        | ✓           | ✓         | ✓         | -             | ✓        | ✓                    | ✓          | ✓             | -                  |
| Color                       | X-Res Technology   | ✓          | ✓        | ✓           | -         | ✓         | ✓             | ✓        | ✓                    | ✓          | ✓             | ✓                  |
|                             | i-Style Color      | -          | -        | -           | ✓         | -         | -             | -        | -                    | -          | -             | -                  |
|                             | Blue Light Reducer | -          | ✓        | ✓           | ✓         | ✓         | -             | -        | -                    | -          | -             | -                  |

✓ : Available

- : Not available



## STANDBY FEATURE

This product features the standby function. When activated, it automatically reduces unnecessary power consumption of the monitor when your computer is not in use.

There is a standby step the monitor takes as described below. The standby function, including any timer settings is configured by the operating system. Check your operating system manual for information on how this can be configured.

### ■ Standby Mode

When the video signal from the computer is off, the monitor enters into Standby Mode which reduces the power consumption to 0.5W or less\*. The screen becomes dark, and the power indicator turns to orange. From Standby Mode, the image reappears in several seconds when either the keyboard or the mouse are touched again.

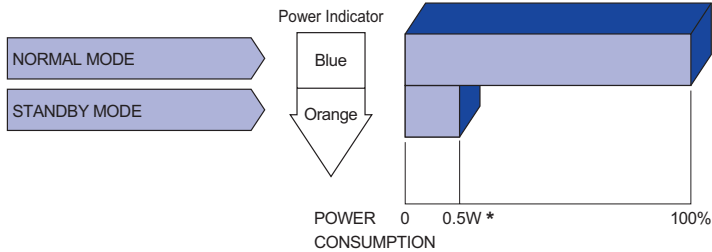

\* When the USB devices are not connected.

# TROUBLE SHOOTING

If the monitor fails to operate correctly, please follow the steps below for a possible solution.

1. Perform the adjustments described in OPERATING THE MONITOR, depending on the problem you have. If the monitor does not get a picture, skip to 2.
2. Consult the following items if you cannot find an appropriate adjustment item in OPERATING THE MONITOR or if the problem persists.
3. If you are experiencing a problem which is not described below or you cannot correct the problem, discontinue using the monitor and contact your dealer or iiyama service center for further assistance.

## Problem

## Check

- ① The picture does not appear.

(Power indicator does not light up.)

(Power indicator is blue.)

(Power indicator is orange.)

- ② The screen is not synchronized.

- ③ The screen position is not in the center.

- ④ The screen is too bright or too dark.

- ⑤ The screen is shaking.

- ⑥ No sound.

- ⑦ The sound is too loud or too quiet.

The Power Cable is firmly seated in the socket.

The Power Button is turned ON.

The AC socket is live. Please check with another piece of equipment.

If the blank screen saver is in active mode, touch the keyboard or the mouse.

Increase the Contrast and/or Brightness.

The computer is ON.

The Signal Cable is properly connected.

The signal timing of the computer is within the specification of the monitor.

If the monitor is in standby mode, touch the keyboard or the mouse.

The computer is ON.

The Signal Cable is properly connected.

The signal timing of the computer is within the specification of the monitor.

The Signal Cable is properly connected.

The signal timing of the computer is within the specification of the monitor.

The signal timing of the computer is within the specification of the monitor.

The video output level of the computer is within the specification of the monitor.

The power voltage is within the specification of the monitor.

The signal timing of the computer is within the specification of the monitor.

The audio equipment (computer etc.) is ON.

The Volume is turned up.

The Mute is OFF.

The audio output level of the audio equipment is within the specification of the monitor.

The audio output level of the audio equipment is within the specification of the monitor.

# RECYCLING INFORMATION

For better environment protection please don't dispose your monitor.  
Please visit our web site: <https://iiyama.com> for monitor recycling.

# APPENDIX

Design and specifications are subject to change without prior notice.

## SPECIFICATIONS : ProLite XUB3293UHSN-B5

ENGLISH

|                                       |   |  |
|---------------------------------------|---|--|
| Size Category                         | 32"   |  |
| LCD Panel                             | Panel technology  | IPS (In-Plane-Switching)   |
|                                       | Size  | Diagonal: 31.5" (80cm)   |
|                                       | Pixel pitch   | 0.182mm H × 0.182mm V  |
|                                       | Brightness  | 350cd/m <sup>2</sup> (Typical), 175cd/m <sup>2</sup> (Default / Energy Saving) |
|                                       | Contrast ratio  | 1000 : 1 (Typical), Advanced Contrast Function Available                       |
|                                       | Viewable angle  | Right / Left: 89 degrees each, Up / Down: 89 degrees each (Typical)            |
|                                       | Response time   | 4ms (Gray to Gray)   |
| Display Colors                        | Approx. 1.07 Billion  |  |
| Sync Frequency                        | HDMI: Horizontal: 30.0-135.0kHz, Vertical: 50-75Hz<br>DisplayPort: Horizontal: 30.0-135.0kHz, Vertical: 50-75Hz<br>USB Type-C: Horizontal: 30.0-135.0kHz, Vertical: 30-75Hz     |  |
| Native Resolution                     | 3840 × 2160, 8.3 MegaPixels   |  |
| Supported max. resolution             | 3840 × 2160, 60Hz   |  |
| Input Connector                       | HDMI, DisplayPort, USB Type-B, USB Type-C (Alt Mode)  |  |
| Input Video Signal                    | HDMI, DisplayPort, USB Type-C (Alt Mode)  |  |
| USB Standard                          | USB3.2 Gen 1 (5Gbps, DC5V, 900mA), USB Power Delivery (65W)   |  |
| Number of USB Ports                   | 2 Upstream: Type-B, Type-C  |  |
| Connector shape                       | 2 Downstream: Type-A  |  |
| LAN Port                              | RJ45  |  |
| Headphone Connector                   | ø 3.5mm mini jack (Stereo)  |  |
| Speakers                              | 3W × 2 (Stereo speakers)  |  |
| Maximum Screen Size                   | 698.1mm W × 392.7mm H / 27.5" W × 15.5" H   |  |
| Power Source                          | 100-240VAC, 50/60Hz, 1.9A   |  |
| Power Consumption* <sup>1</sup>       | 48W (Typical), 33W (Default / Energy Saving)<br>Standby mode: 0.5W maximum, Off mode: 0.3W maximum  |  |
| Dimensions* <sup>2</sup> , Net Weight | 714.0 × 452.0 - 602.0 × 245.5(239.5)mm / 28.1 × 17.8 - 23.7 × 9.7(9.4)"<br>(W×H×D)<br>9.9kg / 21.8lbs   |  |
| Height Adjustment Range               | 150mm   |  |
| Angle                                 | Tilt: Upward: 23 degrees, Downward: 5 degrees<br>Swivel: Left / Right: 45 degrees each  |  |
| Environmental Considerations          | Operating: Temperature 5 to 35°C / 41 to 95°F<br>Humidity 10 to 80% (No condensation)<br>Storage: Temperature -20 to 60°C / -4 to 140°F<br>Humidity 10 to 85% (No condensation) |  |
| Approvals                             | CE, UKCA, TÜV-Bauart, EAC, VCCI, PSE  |  |

**NOTE** \*<sup>1</sup> When the USB devices are not connected.

\*<sup>2</sup> ( ) : Depth of the Stand-Base

## DIMENSIONS

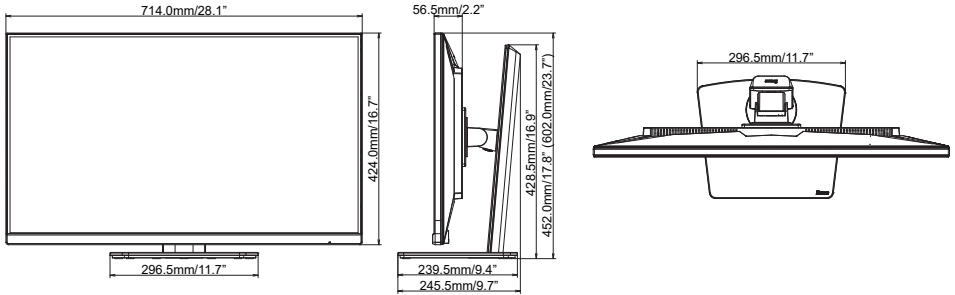

( ) : Maximum adjustment range

## COMPLIANT TIMING

| Video Mode  | Horizontal Frequency | Vertical Frequency | Dot Clock  |
|-------------|----------------------|--------------------|------------|
| 800 × 600   | 37.879kHz            | 60.317Hz           | 40.000MHz  |
|             | 46.875kHz            | 75.000Hz           | 49.500MHz  |
| 1024 × 768  | 48.363kHz            | 60.004Hz           | 65.000MHz  |
|             | 60.023kHz            | 75.029Hz           | 78.750MHz  |
| 1280 × 1024 | 63.981kHz            | 60.020Hz           | 108.000MHz |
|             | 79.976kHz            | 75.025Hz           | 135.000MHz |
| 1920 × 1080 | 66.590kHz            | 59.930Hz           | 138.500MHz |
|             | 83.930kHz            | 75.000Hz           | 174.564MHz |
| 2560 × 1440 | 88.787kHz            | 59.951Hz           | 241.500MHz |
| 3840 × 2160 | 88.860kHz            | 30.000Hz           | 241.699MHz |
|             | 135.000kHz           | 60.000Hz           | 594.000MHz |

### NOTE

\*1 Available only for USB Type-C input with setting "USB-C" to 3.0 in the "Setup Menu".

\*2 In case of USB Type-C input, available only when "USB-C" in the "Setup Menu" is set to 2.0. The source graphic card must be capable of supporting 3840 × 2160 resolution at 60Hz.